

Colliers

CROWN

PROPERTY MANAGEMENT

5395 - 5409 Eglinton Avenue W, Toronto

Available Area:
1,278 - 7,736 SF



Close to Hwy 401,
Hwy 427 & Airport



Free Surface
Parking

[View Website](#)

Adam Dauphinee**

Senior Vice President, LEED, AP
+1 416 620 2872
adam.dauphinee@colliers.com

Chris Burans*

Senior Vice President
+1 416 620 2866
chris.burans@colliers.com

Noel Cardy

Sales Representative
+1 416 620 2364
noel.cardy@colliers.com

For Lease

Centennial Centre - A Boutique Office Community With Available Suites

The building boasts attractive features including proximity to HWY 401, HWY 427, Public Transit: TTC, MiWay and Renforth GO at doorsteps.

Net Rent: \$15.50 PSF

Additional Rent: \$14.32 PSF

Parking 3.2 : 1,000 SF

5405

5407

5403

5409

5401

5399

5397

5395

Colliers

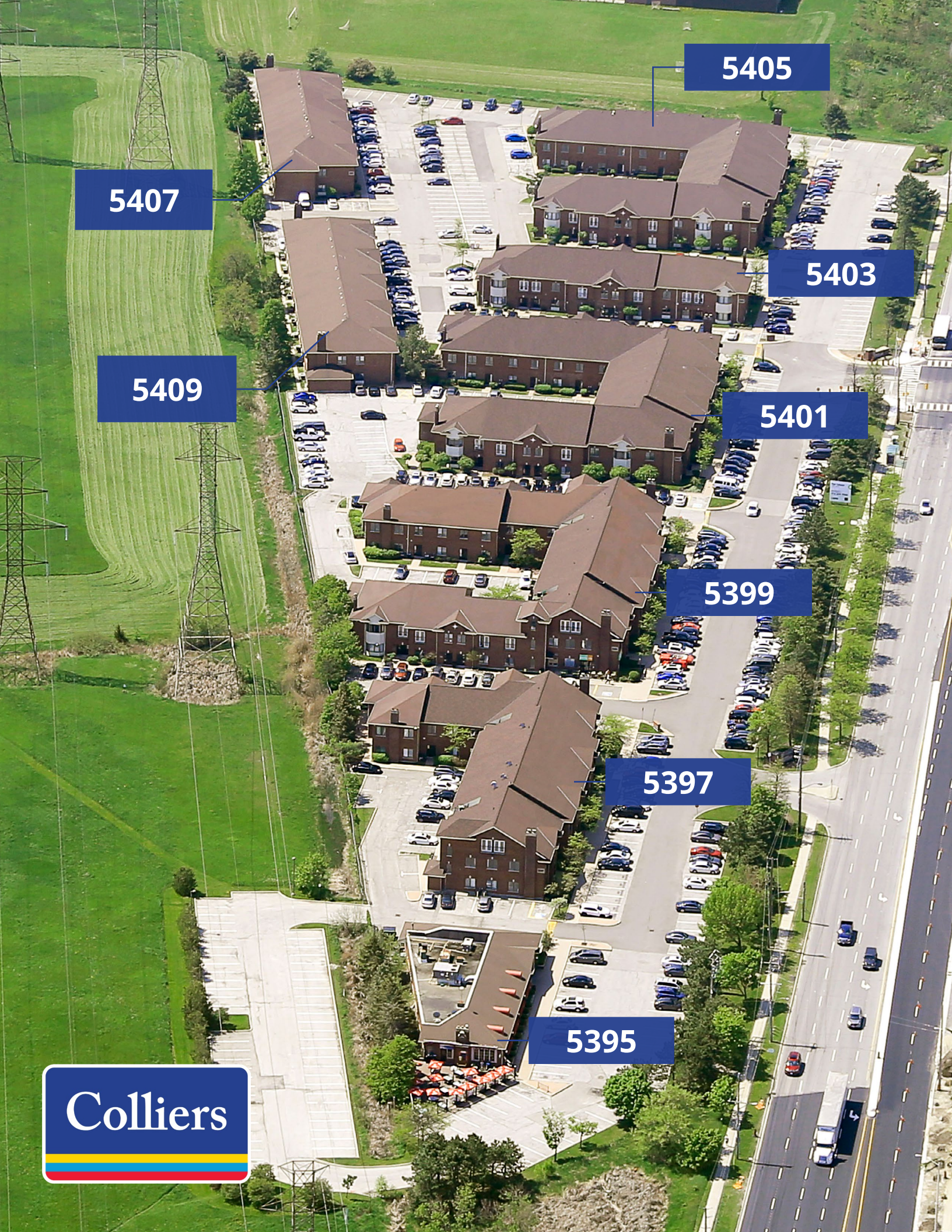

5395-5409 Eglinton Avenue W, Toronto, Ontario

Property Overview

Address 5395-5409 Eglinton Avenue W, Toronto

Area Eringate-Centennial-West Deane

Location Eglinton Ave W & Commerce Blvd

Available Immediately

Lease Type Head Lease

Parking 4 : 1,000 SF

Rentable Suite Options Please see the following Pages

Net Rent \$15.50 PSF

Additional Rent \$14.32 PSF

Building Class Class A

of Floors 2 Floors

Transportation Hwy 401, Hwy 427, TTC & MiWay Bus stop & Renforth GO Station at Doorstep



Key Highlights



Numerous restaurants nearby



Walking distance to banks



Surface parking available



Highway access

Property Availability

Rentable Suite Options

5395 Eglinton Avenue West

Fully leased

5397 Eglinton Avenue West

Suite 208 5,671 SF Immediate

Suite 220 7,736 SF Immediate

5399 Eglinton Avenue West

Suite 204 1,388 SF Immediate

5401 Eglinton Avenue West

Suite 108 1,490 SF Immediate

Suite 204 1,785 SF Immediate

Suite 205 4,334 SF Jan 1, 2024

Suite 211 4,200 SF Immediate

5403 Eglinton Avenue West

Fully leased

5405 Eglinton Avenue West

Suite 105-108 6,340 SF Immediate

Suite 201 1,675 SF Immediate

Suite 206 6,588 SF Immediate

5407 Eglinton Avenue West

Fully leased

5409 Eglinton Avenue West

Suite 206 1,278 SF Immediate

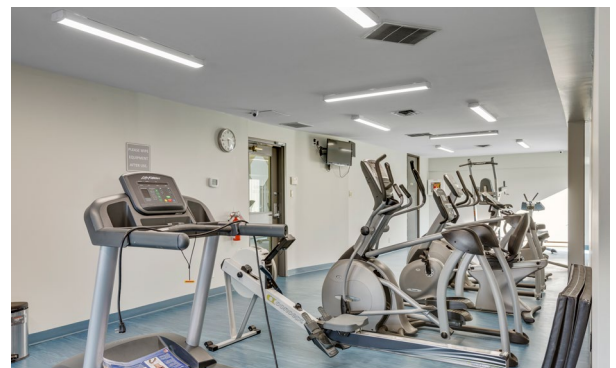

Floor Plan Overview

5397 Eglinton Avenue West Floor Plan

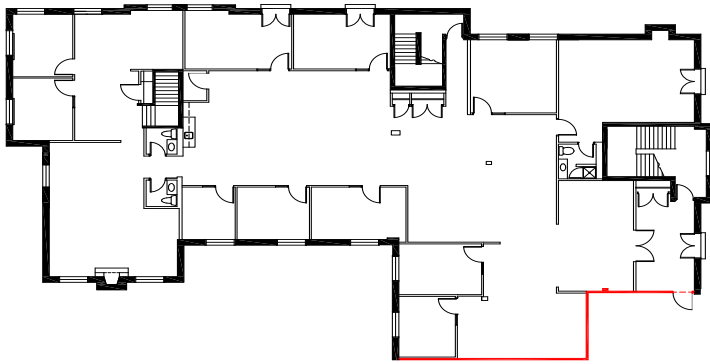

Suite 208

5,671 SF

- Built-Out Suite
- Bright Open Area
- Private Offices, Meeting Rooms & Boardroom
- Full Kitchen

[Virtual Tour](#)

5397 Eglinton Avenue West Floor Plan

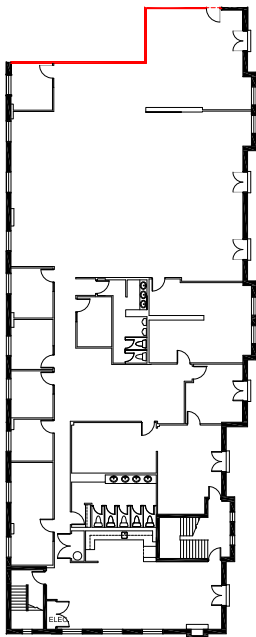

Suite 220

7,736 SF

- Multiple Private Offices
- Private Washroom
- Boardroom
- Full Kitchen
- Lots of Natural Light

[Virtual Tour](#)

Floor Plan Overview

5399 Eglinton Avenue West Floor Plan

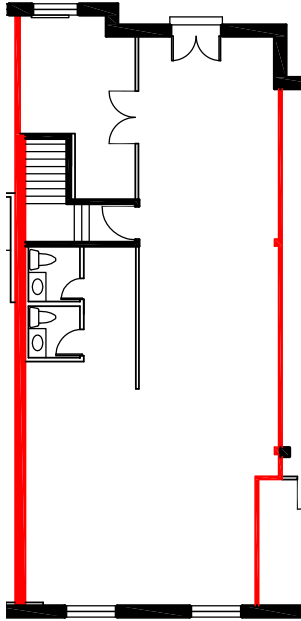

Suite 204

1,388 SF

- Second floor suite
- Three private offices
- Bright Open Area
- Private washrooms

5401 Eglinton Avenue West Floor Plan

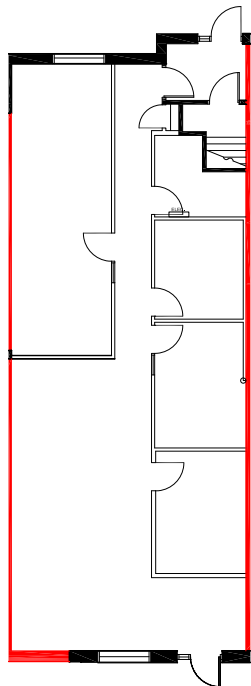

Suite 108

1,490 SF

- Built Out Suite
- Private Washroom

[Virtual Tour](#)

Floor Plan Overview

5401 Eglinton Avenue West Floor Plan

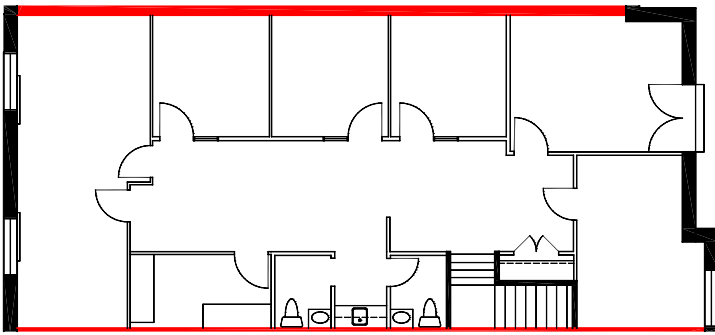

Suite 204

1,785 SF

- Efficient layout with multiple offices and kitchen.

5401 Eglinton Avenue West Floor Plan

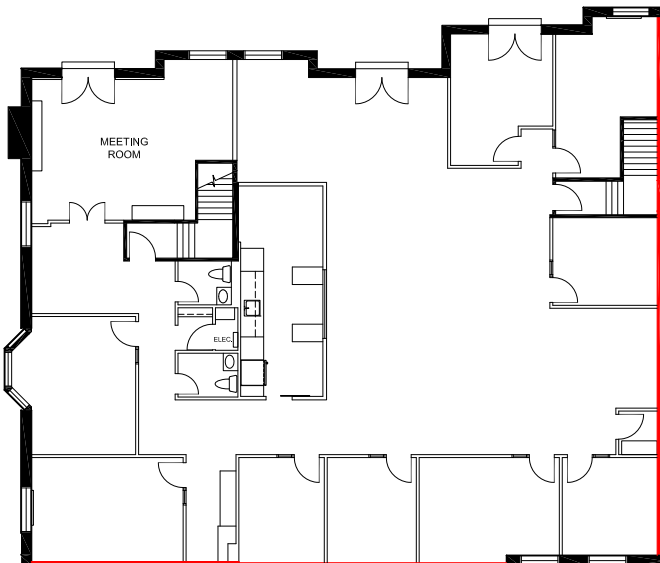

Suite 205

4,334 SF

- Private Offices
- Meeting Room
- Kitchenette
- Open work area

Floor Plan Overview

5401 Eglinton Avenue West Floor Plan

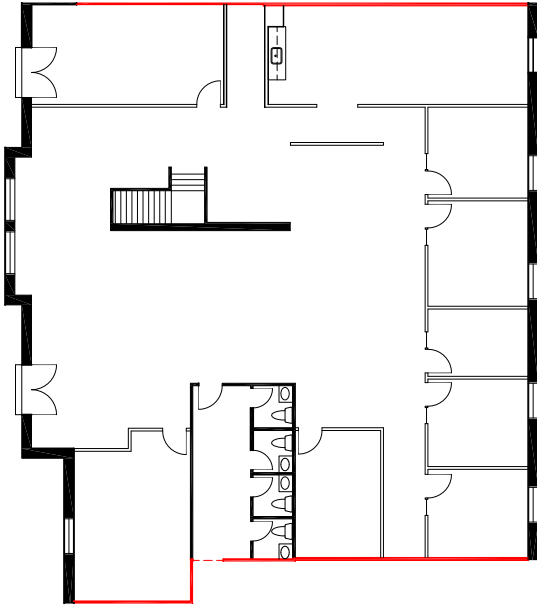

Suite 211

4,200 SF

- Fully-furnished model suite
- Private Offices
- Meeting Room
- Kitchenette
- Open work area
- Ensuite washrooms

5405 Eglinton Avenue West Floor Plan

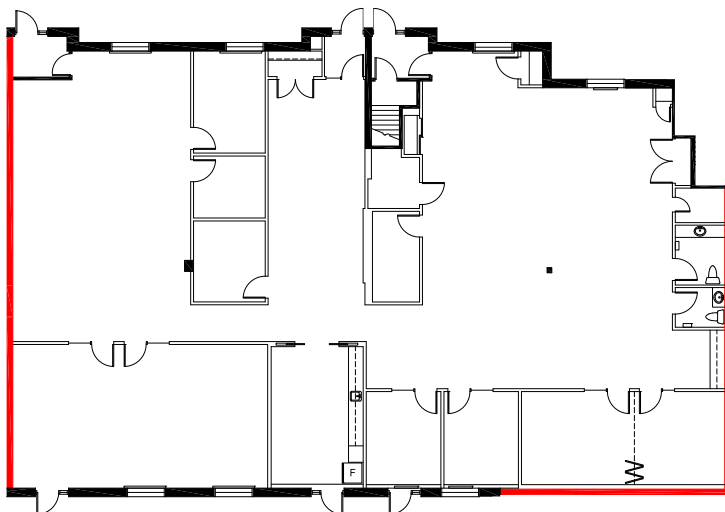

Suite 105-108

6,340 SF

- Private Offices
- Kitchenette
- Private Washroom

Floor Plan Overview

5405 Eglinton Avenue West Floor Plan

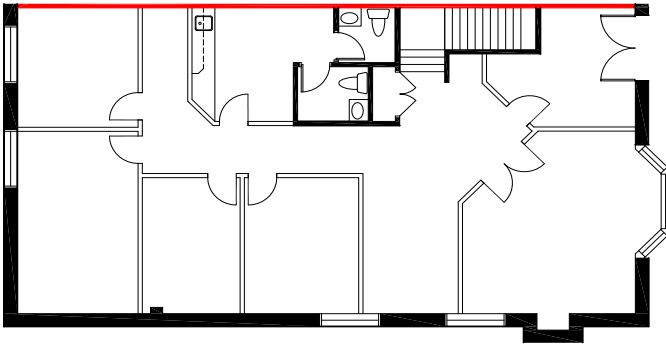

Suite 201

1,675 SF

- Private Offices
- Meeting Rooms / Spaces
- Kitchenette
- Private Washroom

5405 Eglinton Avenue West Floor Plan

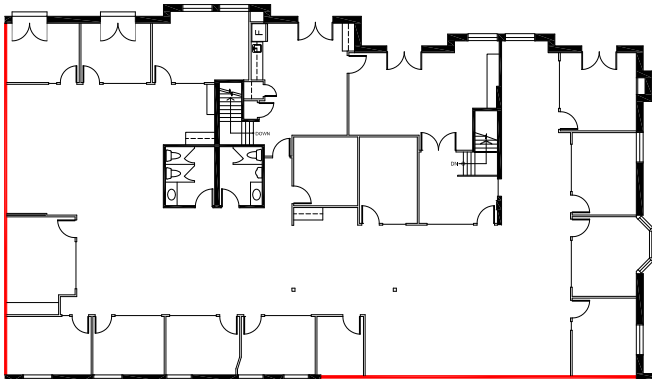

Suite 206

6,588 SF

- Beautifully Finished with High Quality Furniture
- Private Offices
- Meeting Room
- Kitchen
- Internal Bathroom
- Lots of Natural Light

[Virtual Tour](#)

Floor Plan Overview

5409 Eglinton Avenue West Floor Plan

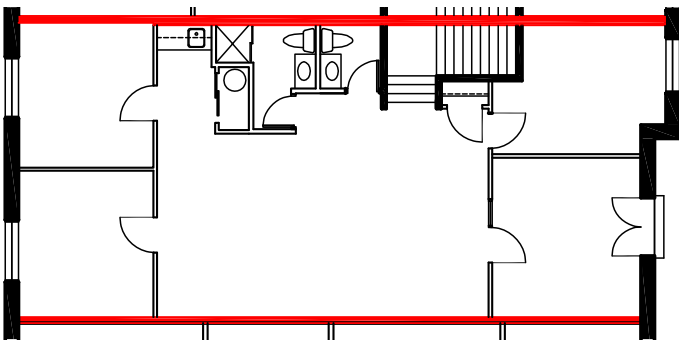

Suite 206

1,278 SF

- Open Area
- Private offices
- Private Washrooms

Building Features

- 3.2 per 1,000 SF parking ratio
- Renforth Station directly across street
- Tenant lounge and fitness centre
- Fibre-optic internet capability

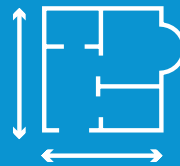

1,278 - 7,736
SF available

Surrounding Amenities

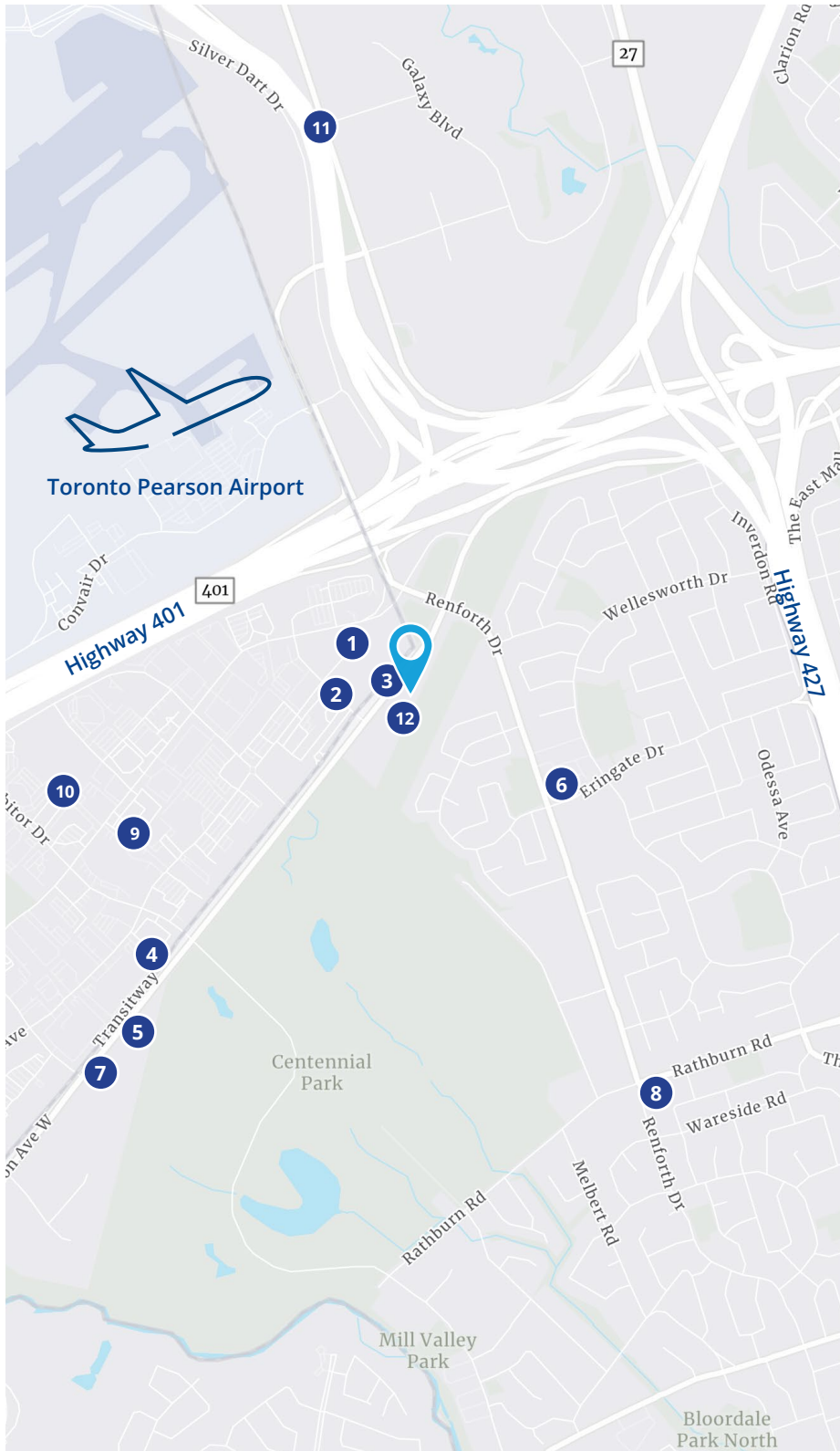

Centennial Centre is conveniently situated on Eglinton Avenue and Renforth Drive with quick access to 400-series highways. Get from car to desk in seconds with ample surface parking or enjoy an easy commute with Renforth Station, connecting to MiWay, GO and the TTC, located directly across the street.

 Subject property

- 1 McDonald's
- 2 The Bull Pub and Grill
- 3 Renforth Transt Hub
- 4 Towneplace Suites by Marriott
- 5 RBC ATM
- 6 BMO Bank of Montreal
- 7 Hampton Inn by Hilton
- 8 Scotiabank
- 9 La Scala Ristorante
- 10 Bravo Bistro
- 11 The Keg Steakhouse and Bar
- 12 Porta Via Restaurant

Travel Distances

Downtown Toronto 25.3 km | 21 Mins

Downtown Mississauga 13.5 km | 12 Mins

Toronto Pearson Airport 3.9 km | 7 Mins

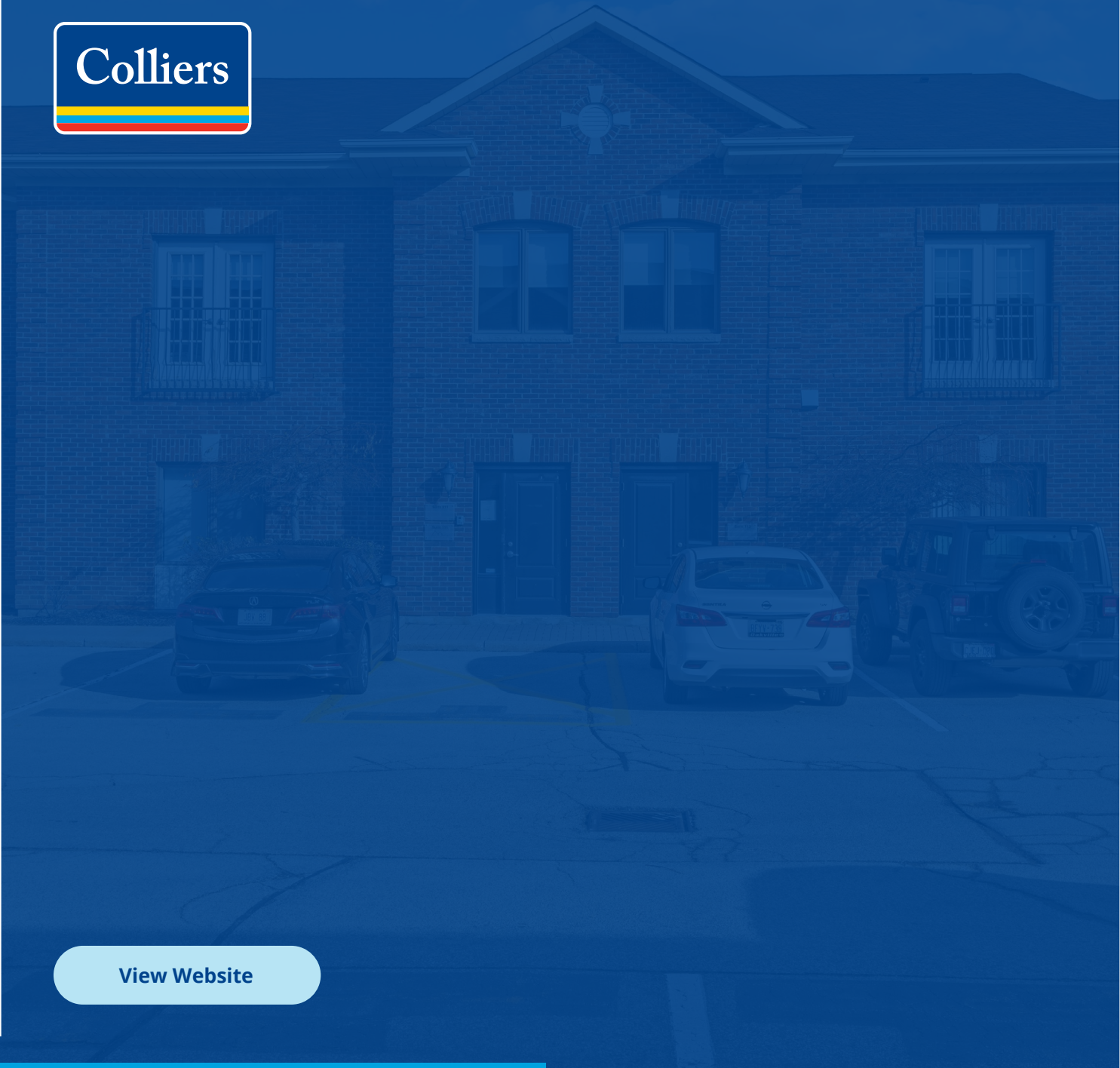

[View Website](#)

5395 - 5409 Eglinton Avenue W, Toronto

Adam Dauphinee**
Senior Vice President, LEED, AP
+1 416 620 2872
+1 416 505 4828
adam.dauphinee@colliers.com

Chris Burans*
Senior Vice President
+1 416 620 2866
+1 416 258 9845
chris.burans@colliers.com

Noel Cardy
Sales Representative
+1 416 620 2364
+1 289 927 1252
noel.cardy@colliers.com

* Sales Representative ** Broker
This document has been prepared by Colliers for advertising and general information only. Colliers makes no guarantees, representations or warranties of any kind, expressed or implied, regarding the information including, but not limited to, warranties of content, accuracy and reliability. Any interested party should undertake their own inquiries as to the accuracy of the information. Colliers excludes unequivocally all inferred or implied terms, conditions and warranties arising out of this document and excludes all liability for loss and damages arising there from. This publication is the copyrighted property of Colliers and/or its licensor(s). Copyright © 2024. All rights reserved. This communication is not intended to cause or induce breach of an existing listing agreement. **Colliers Macaulay Nicolls Inc., Brokerage**